



# REHID

## Infrared Heating Panels

# Installation Manual



**UK Head Office**

Kemp House, 152 City Road, London EC1V 2NX

☎ 02071128018 📠 02071128018

✉ info@rehhd.com 🌐 www.rehhd.com

# Contents

<b>1. General Product Information</b>	<b>2</b>
1.1. General Information About Infrared Radiant Panels	2
1.2. General Information About REHHD Panels	2
1.3. Various Applications and Models	3
<b>2. Safety Notes Before First Use</b>	<b>4</b>
2.1. General Safety Instructions	4
2.2. Special Safety Instructions	4
<b>3. Instructions for Installation and Use</b>	<b>5</b>
3.1. Instructions for Mounting	5
3.2. Instructions for First Use	6
3.3. Instructions for Regular Use	7
3.4. Instructions for Cleaning and Maintenance	7
3.5. Instructions for Repair	7
<b>4. Technical Details</b>	<b>8</b>
<b>5. Wall Mounted Installation</b>	<b>9</b>
<b>6. Ceiling Mounted Installation</b>	<b>10</b>
<b>7. Environmental Protection</b>	<b>11</b>
<b>8. Transportation and Delivery</b>	<b>11</b>
<b>9. Occurrence of an Error</b>	<b>12</b>
<b>10. Warranty</b>	<b>12</b>

# I. General Product Information

REHHD heating panels operate on electricity. According to this definition, these devices can be dangerous. It is, therefore, necessary to read these instructions carefully before use. If you have questions, we are also happy to help. Keep this manual in the vicinity of the device.

## 1.1. General Information about Infrared Radiant Panels

REHHD radiant panels are direct heating systems that use the principle of infrared heat radiation. They have very low energy consumption and achieve a pleasant and comfortable indoor climate. The heat conductor is carbon fiber.

REHHD panels convert electrical energy into heat with nearly 100% efficiency. A special coating on the surface is optimized so as to achieve maximum heat dissipation in the wavelength range from 7 to 10  $\mu\text{m}$ .

REHHD radiant panels heat a room just as the sun warms the earth. REHHD brings this infrared heat into your home, minimizing your heating costs. The panels also have a healthful effect on the human body. The heat has a positive effect on the human heart, especially for the elderly, children and newborns. It also has a very effective impact on people who are restricted in their movement.

The use of REHHD panels can improve your overall health. When the panels are in use, only 80% of traditional heating is needed, because the panels can boost the feeling of warmth in a room. Compared with traditional heating, savings up to 30% can be achieved with REHHD infrared heating panels. In transitional periods, this can rise to 60%.

## 1.2. General Information about REHHD Panels

REHHD radiant panels can be used in different rooms and environments (for each application, see Section 1.3.). Depending on the environment and nature of the desired application, various models are recommended (to find the best model for you, please contact your dealer). For all models and applications, be sure to follow the safety instructions for installation (see Section 3.1.).

REHHD radiant panels heat up in about 5 to 10 minutes. Your room will not feel warmer immediately, because the cold objects in the room (furniture, walls, ceilings, floors, etc.) need to warm up first. Once these things are heated, the warmth will spread through out the room and you will be able to reduce the length of time in which the heating panel is in operation. Hence, you can save a great amount of energy. Depending on which REHHD model you have selected, the surface will heat from (80 to 85 °C).

All REEHD heating panels are equipped with temperature sensors that regulate the surface of the unit so that they do not overheat. REHHD heating panels can also be used for different environmental applications. For further details, see Section 1.3.

## 1.3. Various Applications and Models

### 1.3.1. Ceiling Panels

In order to heat a room optimally, REHHD panels should be attached to the ceiling. This optimizes the radiation. Plus, it saves space. REHHD panels are light enough to be integrated into existing ceiling systems. Please note the necessary details for instructions described in Section 3.1.

### 1.3.2. Wall Panels

REHHD wall panels can be optimally used as a supplementary or primary heating system. Due to their thin and light structure and the differences in surface design, the panels are compact and suitable for almost all walls (please see the instructions for installation in Section 3.1.). Depending on the mounting position, REHHD wall panels have a convection heat share of almost 0%.



# 2. Safety Notes Before First Use

## 2.1. General Safety Instructions

- ⓘ All REHHD heating panels are only suitable for use as a heating element. Any improper use can present a significant danger to people, animals and the environment.
- ⓘ REHHD heating panels are not intended to be used by people (including children) with reduced physical, sensory or mental abilities or lack of experience and/or knowledge, unless they are supervised by a person responsible for their safety or have received instructions on how to use the device.
- ⓘ All heating panels must be kept away from children. Children should be supervised to ensure they do not play with the device.
- ⓘ REHHD heating panels are not suitable for use in rain or wet conditions, under water, and for any non-intended use.
- ⓘ For all REHHD heating panels, please observe the following installation instructions (see Section 3).
- ⓘ Each REHHD heater has a built-in safety switch that turns off the heating element automatically if it is overheating. By unplugging the unit and waiting for about 10 to 15 minutes, the safety switch is activated automatically and the unit is operational again.

## 2.2. Special Safety Instructions

- ⓘ DO NOT COVER. Warning: To avoid overheating, the heater must not be covered. Never cover the REHHD heating panel. This can cause heat buildup.
- ⓘ The heater is very hot when in use (depending on model, up to 125° C or 257°F). Contact could lead to serious burns.
- ⓘ Each REHHD heater is equipped with a power cord and plug. By using an optional adapter, you can operate the heater with a room thermostat. Make sure that nobody can trip over the cable. Protect the unit from overloading the circuit breaker, and operate the equipment only as specified on the nameplate.
- ⓘ Do not use the REHHD heating panel if the power cord or plug is damaged. This should be checked before each use. Do not drag or tear the main cable. Do not scrub the cable, and do not clamp the cable. Neither the cable nor the plugs may be repaired or replaced. In case of damage, contact the manufacturer or distributor.
- ⓘ Never dip REHHD heating panels into water or put them in water. Also, people should never touch the heating element while they are in the bathtub or shower. Do not use this device near a bathtub shower or swimming pool.
- ⓘ The heating panel can only be operated in a permanently mounted position (for more information on mounting, see Section 3.1.).
- ⓘ In case of damage to the heating panel or the circuit cable, immediately disconnect it from the circuit. (For further information about the warranty process, see Section 8).
- ⓘ To prevent damage and accidents, never open the device (see the detailed information described in Section 3.5.). If the device is opened, warranty and liability claims are not approved.

# 3. Instructions for Installation and Use

## 3.1 Instructions for Mounting

REHHD panels must be mounted with the supplied original mounting hardware (aluminum profiles at the back of the panels and screws included). For panels that are used without the original mounting hardware, the warranty, liability and consequential damages are void.

REHHD panels must only be used in the manufacturer-related frames. For panels that are used without the original frame, the warranty, liability and damages are void.

### 3.1.2. General Instructions for Mounting

- ⦿ Depending on the desired application (see Section 1.3.), different types of installation are provided. All REHHD panels come with original mounting hardware (aluminum profiles at the backside of the panels and screws for wall/ceiling mounting are enclosed).
- ⦿ Make sure that the power plug is not plugged in during assembly. During installation of the unit, also make sure that the heating panel is not in the "ON" position.
- ⦿ Do not make any holes in the heating panel. If holes have been made for any reason, do not operate the device. Please contact the manufacturer or dealer from whom you purchased the product.
- ⦿ To ensure a quick and easy installation, use the enclosed mounting template and follow the instructions for installation as described in detail.
- ⦿ If the device is installed in children's rooms or rooms accessible to children, make sure that the device is suspended at least 4 feet above the ground.
- ⦿ **DISTANCE TO BACKSIDE:** REHHD panels output convection heat (not infrared radiation) at the backside only. Make sure that the distance from the wall to the back of the heating panels (metal/aluminum plate) is at least 1 inch in order to ensure ventilation. This distance is always provided when you use the standard mounting hardware. If you use a different mounting system than the original, warranty as well as liability for consequential damages is void.
- ⦿ **DISTANCE TO FRONTSIDE:** REHHD panels send out infrared radiation only on the front side. Make sure that there is a minimum distance of 10 inches between the front of the panel and any objects.
- ⦿ Do not mount the heating panel near a shower, tub or swimming pool. Make sure that the heating panel cannot be touched by any person who is in the bath or shower. In case of installation in wet rooms, the installation must be done by a licensed electrician.
- ⦿ Never mount the heating element in front of or immediately below a socket.
- ⦿ Make sure that the plug is accessible after installation of the panels and, if needed, can be immediately pulled.
- ⦿ If the heating panel is integrated in a permanent electrical installation or connection, a correctly sized circuit breaker is needed. This connection has to be carried out by a qualified professional.

### 3.1.3. General Information on Positioning

With infrared radiation, improper positioning can result in certain areas of space in a room experiencing a “shadow” effect. Optimal positioning can avoid shadow effects. For detailed information about the optimal positioning, please consult your dealer where you purchased the REHHD panel.

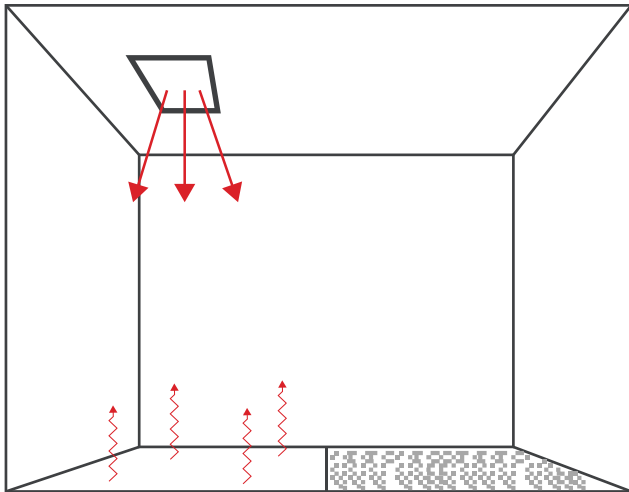

Good positioning

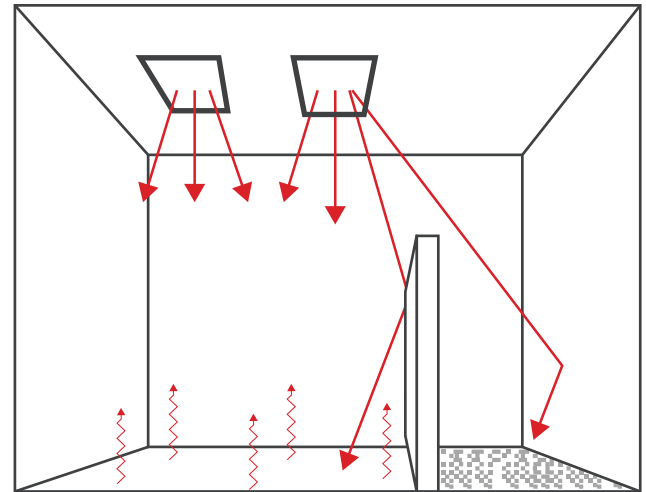

Bad positioning

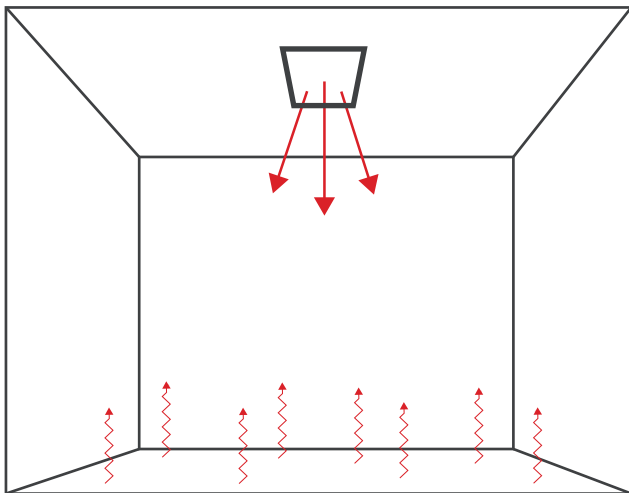

Good positioning

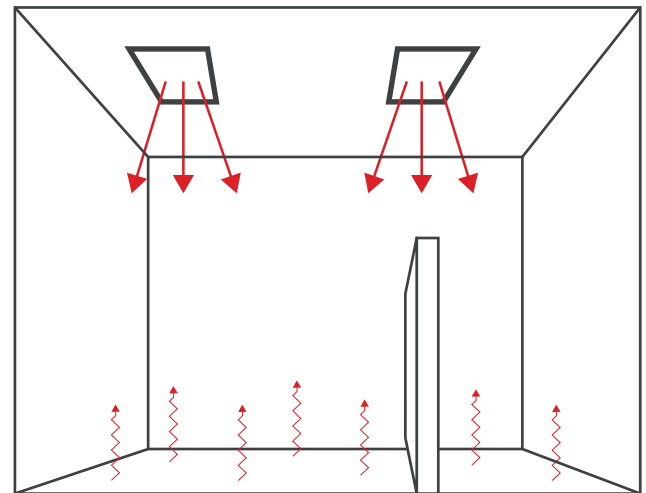

Bad positioning

## 3.2. Instructions for First Use

- ⦿ Note that Section 3.1. mentioned instructions for assembly.
- ⦿ Now connect the heating panel to a perfectly placed and installed pair of sockets (note the instructions mentioned above for safety).
- ⦿ Now the heating panel can be put into operation. The startup heating time is approximately 5 to 10 minutes. Your room will not feel warmer immediately, because the cold objects in the room (furniture, walls, ceilings, floors, etc.) need to warm up first. Once these surfaces are heated, the warmth will spread throughout the room and you will be able to reduce the duration of time in which the heating panel is in operation.

### 3.3. Instructions for Regular Use

- ⓘ Do not place any clothing or other similar items on the heating element (FIRE DANGER). A sign is mounted on the front of the panel and must not be removed.
- ⓘ When heating up or cooling down, the expansion and contraction of the heating panels can cause minimal noise. This is normal.
- ⓘ The heater is very hot in use. Contact could lead to serious burns.
- ⓘ All REEHD heating panels are equipped with temperature sensors that regulate the surface of the unit and prevent it from overheating.
- ⓘ If you do not use the heating panel for an extended period of time, it is advisable to unplug the unit.
- ⓘ The surface of the heating panels should be kept clean. Please refer to the instructions in Section 3.4.

### 3.4. Instructions for Cleaning and Maintenance

- ⓘ REHHD panels do not require any maintenance. If you find any irregularities, unplug the power cord immediately and contact your dealer, from which you purchased the panel. To achieve the best results when cleaning, follow these steps:
  - ⓘ Before cleaning, unplug the unit.
  - ⓘ The heater is very hot during use (depending on model, up to 85°C, BURNING DANGER). Before you clean the heating element, let it cool down for about 10 to 15 minutes.
  - ⓘ Do not immerse the heating panel in water or spray it off. Never use a wet cloth. Clean with a duster or slightly dampened cloth. Make sure that the heating element is completely dry before powering on the unit.
  - ⓘ Do not use abrasives or other harsh cleaning products or rough cloths.
  - ⓘ For ceiling panels, occasionally remove any dust on the top with a vacuum cleaner.

### 3.5. Instructions for Repair

- ⓘ In case of irregularities with the devices, always contact your dealer. Do not repair them yourself.
- ⓘ If a malfunction occurs, immediately disconnect the power cord. Do not use, or stop use immediately, if the unit is damaged, especially if the line cord, housing or heating panel itself are affected.
- ⓘ In addition, we ask you to carefully read the details in Section 8 about the processing of warranty claims. Never remove the label or the warning sticker. The data on the nameplate are important for the
- ⓘ warranty.



## 4. Technical Details

The following information provides general information applicable to the REHHD radiant panel line. Please find additional information about performance, size and surface temperature on the sticker located on the back of the panels.

### INFRARED PANEL

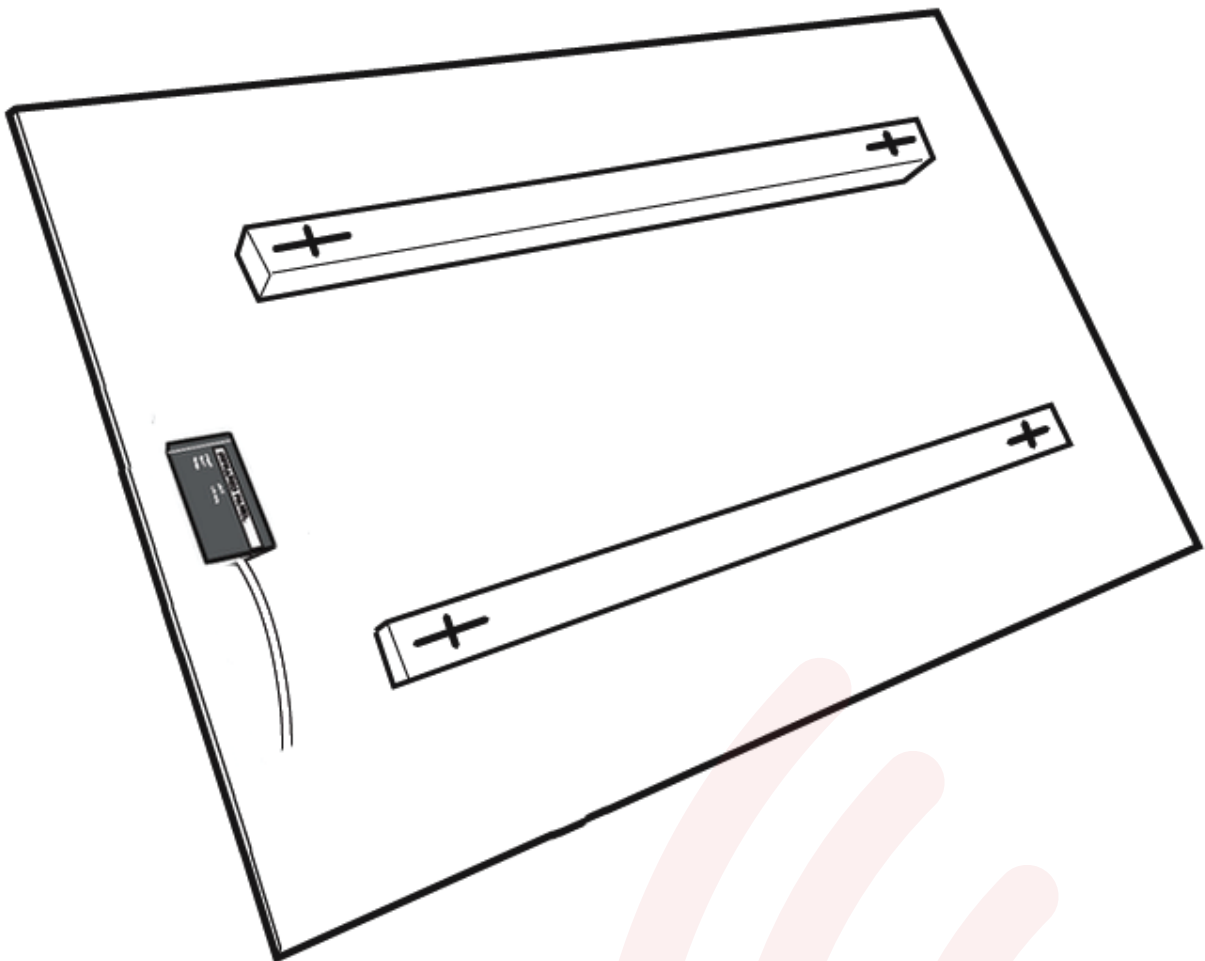

# 5. WALL MOUNTED INSTALLATION



1

Make sure wall is clean and flat.



2

Make sure you have all the tools required for the job.



3

Measure position of panel.

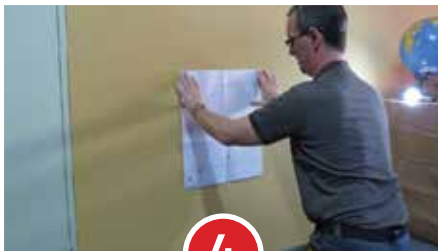

4

Using the template line up the position and using low tech adhesive fix in place.



5

Secure all corners making sure the template is flat to the wall.

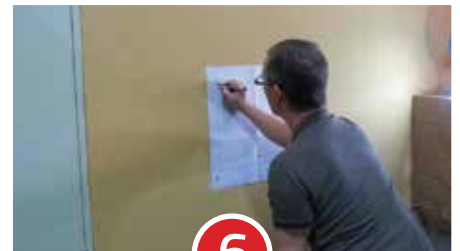

6

Secure all corners making sure the template is flat to the wall.



7

Remove tape carefully as to not damage the decor and then mark directly onto wall for drilling.



8

Using the plastic plugs provided drill out the holes.

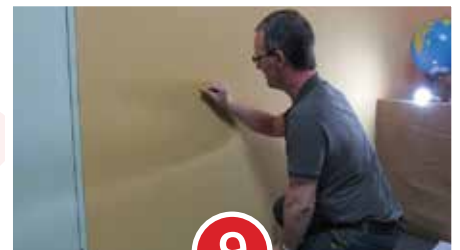

9

Fix plastic plugs and screw in 4.2mm counter sunk screw.

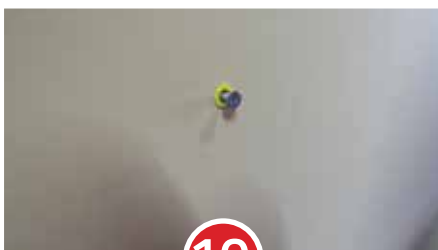

10

Leave 6mm of screw head protruding.



11

Note position of fixing rebates on the back of the panel.



12

Position fixing rebates in middle of wall and push back into position, pulling down gently to lock in place.

# 6. CEILING MOUNTED INSTALLATION



1

Make sure ceiling is clean and flat



2

Make sure you have all the tools required for the job.



3

Measure position of panel

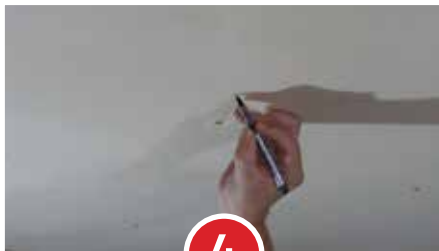

4

Using the template line up the position and using low tech adhesive fix in place.

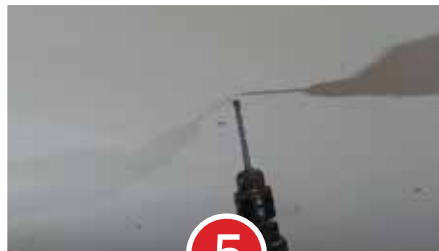

5

Secure all corners making sure the template is flat to the ceiling.

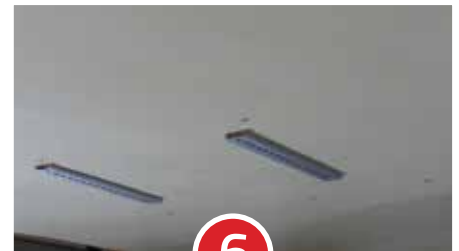

6

Mark the pre-determined holes onto ceiling.



7

Remove tape carefully as to not damage the decor and then mark directly onto ceiling for drilling.

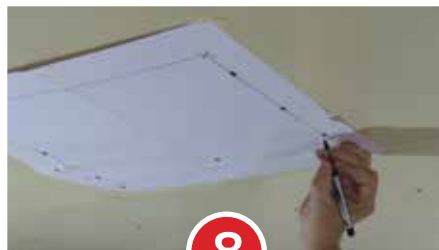

8

Drill holes with a No8 drill bit and then use plastic plugs provided for concrete or plaster board.

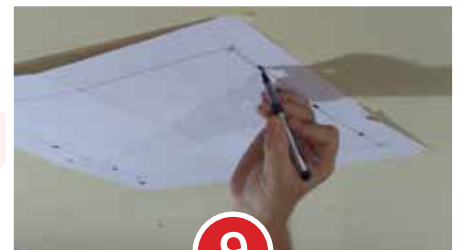

9

Screw rails in place using screws provided making sure that the rails are fitted the correct way.



10

Screw clips onto the back of the panel making sure that they are secure.



11

Carfully lift the panel towards the rails making sure they're in line.



12

Gentle push the panel towards the ceiling and make sure it is securely fixed.

## 7. Environmental Protection

Please note the following guidelines for disposing of packaging materials:

- ⦿ Packaging material made of cardboard can be recycled.
- ⦿ Keep plastic foils or packaging out of the hands of children. Please recycle the protective film properly.
- ⦿ The heater, or parts thereof, may not be disposed with normal household waste, but must be taken to a collection point for recycling of electronic and electric devices. The symbol on the product, on the packaging and on this manual indicates this.
- ⦿ By recycling, you make an important contribution to protecting our environment. Please ask for details at your local authority or the appropriate disposal location.



## 8. Transport and Delivery

The following information provides general information applicable to the REHHD radiant panel line. Please find additional information about performance, size and surface temperature on the sticker located on the back of the panels.

# 9. Occurrence of an Error

Dear Customer,

Thank you for choosing a product from REHHD. Should there be an issue with your device, we ask you to first contact the dealer from which you purchased the device. Should the problem not be solved in this way, please send your device back to the dealer and enclose the following warranty card.

- ☞ REHHD provides on all REHHD radiant panels a 10 year warranty, from the date of purchase. Proof of purchase is a guarantee slip.
- ☞ Excluded from the warranty are external optical defects, beyond the damage caused by improper installation or faulty handling, or removed or obliterated serial numbers or mechanical damage.
- ☞ Repairs by unauthorized third parties voids the warranty claim.
- ☞ The warranty covers the repair or replacement of the defective part. Labor is not included.

**Please call REHHD at 020 7112 8018 for 24/7 troubleshooting assistance.**

# 10. Warranty Card

REHHD

## Warranty Information

Please complete and return the Warranty Card.

info@rehhd.com or call 020 7112 8018 to register via phone

NAME			TEL:
ADDRESS			
CITY	EMAIL		
COUNTRY	ZIP CODE		
PRODUCT S/N NUMBER			

NAME			TEL:
ADDRESS			
CITY	EMAIL		
COUNTRY	ZIP CODE		
PRODUCT S/N NUMBER			

REHHD® WARRANTIES ("the Product") to be free from defects in materials and workmanship for 5 years from the date of sale, provided that the Product is installed in accordance with the accompanying Installation Manual, and any special written design or installation guidelines provided by REHHD. for this product, the National Electric Code (NEC) and all applicable local building and electrical codes. REHHD makes no claim as to the amount of room temperature rise, the amount of time it takes to reach a given room temperature, or the final room temperature due to the innumerable variables in building construction and environmental conditions. Any suspected defect must be reported immediately upon discovery. The determination of such a defect must be made by REHHD or its authorized representative only. This warranty is null and void if the product is improperly installed, improperly operated, or abused. REHHD assumes no responsibility under this warranty for any damage to the product caused by any trades person, or visitor on the job site, or damage caused as a result of post installation work. Under this Limited Warranty, REHHD. will provide the following remedy: If the Product is determined to be defective in materials and workmanship, and has not been damaged as a result of misuse or misapplication, REHHD. will refund the original purchase price or replace the Radiant Panel, at REHHD. expense. REHHD. will not be liable for the labor required to replace the Radiant Panel. The Limited Warranty is null and void if the project owner or his representative attempts to repair the Product without receiving authorization. Upon notification of a real or possible problem, REHHD, will issue an Authorization to Proceed under the terms of the Limited Warranty. Unit must be inspected for shipping damage at time of delivery. Warranty claims will not be accepted on damaged units that are installed. REHHD. is not liable for loss or damage of the device due to improper installation, theft, fire, earthquake or other natural occurrences. Warranty is void if the REHHD unit is fitted with unauthorized replacement parts, or non-approved additional components. REHHD is not designed to come in contact with any item. Any damage to an item that contacts the REHHD, or damage to REHHD as a result of contact with an item, shall not be covered under this warranty. Warranty is voided if the serial number tag is removed, damaged, or altered in any way.

**REHHD** DISCLAIMS ANY WARRANTY NOT PROVIDED HEREIN, INCLUDING ANY IMPLIED WARRANTY OF MERCHANTABILITY OR IMPLIED WARRANTY OF FITNESS FOR A PARTICULAR PURPOSE. REHHD. FURTHER DISCLAIMS ANY RESPONSIBILITY FOR SPECIAL, INDIRECT, SECONDARY, INCIDENTAL, OR CONSEQUENTIAL DAMAGES ARISING FROM OWNERSHIP OR USE OF THIS PRODUCT, INCLUDING INCONVENIENCE OR LOSS OF USE. THERE ARE NO WARRANTIES WHICH EXTEND BEYOND THE FACE OF THIS DOCUMENT. NO AGENT OR REPRESENTATIVE OF REHHD. HAS ANY AUTHORITY TO EXTEND OR MODIFY THIS WARRANTY UNLESS SUCH EXTENSION OR MODIFICATION IS MADE IN WRITING BY A CORPORATE OFFICER.



**UK Head Office**

Kemp House, 152 City Road, London EC1V 2NX

☎ 02071128018 📠 02071128018

✉ info@rehhd.com 🌐 www.rehhd.com